

NHL100 - LED Highbay



The NHL100 LED high bay consist of a die-cast aluminium alloy body and is polyester epoxy powder coated, which makes it ideal for indoor and outdoor applications. This luminaire provides high energy efficiency, excellent illumination, low maintenance and long lifespan. Various mounting options include Hook, Ceiling and Wall mount. The addition of Motion and Daylight sensors allows for even further energy savings especially in areas which are less occupied. Dali dimmable gear are also available on request.



RAMIKA PROJECTS

NFL100 - LED Highbay

Applications: Warehouses / Industrial Facilities / Exhibition Centers / Shopping Malls / Indoor Sports / Aircraft Hangers

Housing: Manufactured from aluminium alloy, with a heavy duty toughened smooth clear glass refractor as standard fitted into the aluminium alloy housing.

Optics & Reflectors: Multiple polycarbonate optic lenses and aluminium reflectors which provides different beam angles available for various applications.

Gasket: The silicone sponge gasket between the glass and housing provides a IP65 seal.

Control Gear: Constant Current LED driver
100V/240V, 50/60Hz

Dimming & Sensors: The addition of Motion and Daylight sensors allows for even further energy savings especially in areas which are less occupied. Dali dimmable gear are also available on request.

Mounting: Various mounting options include Hook, Ceiling and Wall mount.

Rated Lifetime: 50 000 Hr. (Ta=30°C@L70)

Warranty: 5 Years

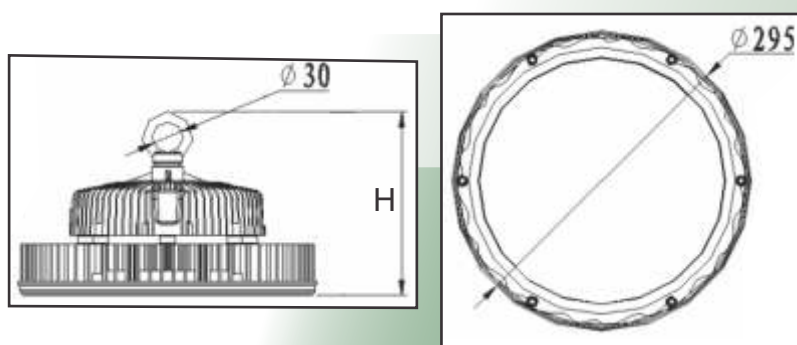

Photometric Data:

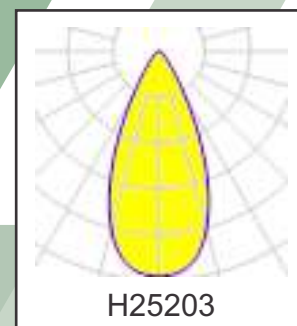
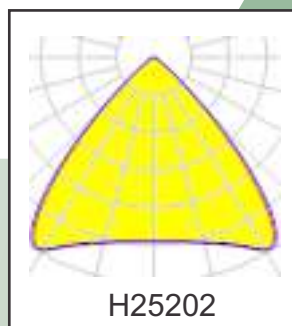
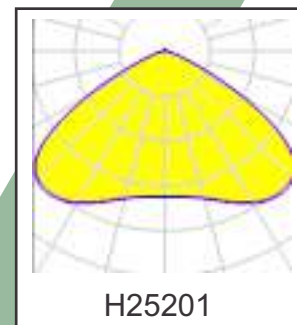
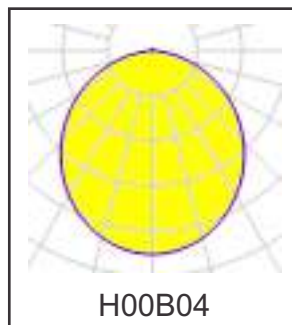
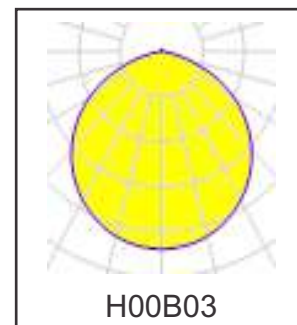
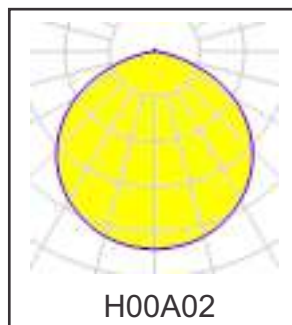

Model Name	NHL100 - LED Highbay			
Rated Wattage(W)	100W	120W	150W	200W
Luminous Flux(LM)	14000lm	16800lm	21000lm	28000lm
Luminous Efficiency	140lm/W (160lm/W Optional)			
Colour Temperature	5000K (3000K,4000K Optional)			
Colour Rendering Index	Ra70 / Ra80			
Rated Voltage	100V-240V AC, 50/60Hz			
Ingress Protection Grade	IP65			
Ambient Temperature	-30°C to +50°C			
Power Factor	>0,90			
Rated Lifetime	50 000 Hr. (Ta=30°C@L70)			
Installation	Hook, Ceiling and Wall Mount			
Beam Angle	H00A02 / H00B03 / H00B04 / H25201 / H25202 / H25203			
Weight	3,9kg	4,2kg	4,2kg	4,8kg
Dimensions	Ø x H	Ø x H	Ø x H	Ø x H
	Ø295x169mm	Ø295x169mm	Ø295x169mm	Ø295x180mm

Ramika Projects reserves the right to change any specification or design without prior notice.